



# Smart Hospitality Display HBU8000 Series (NA)

43 50 55 65 75

## HIGHLIGHTS

- Quick access to leading streaming services
- Enhance content with 4K UHD Crystal Display for perfect picture quality
- Slim design that complements any interior while saving space
- Centralized management of hotel displays worldwide
- Optimize promotions and offers using personalized guest insights

## Key features



## Let your guests access their most loved content

Modern guests are seeking the same home amenities and comforts while choosing their next hotel. To deliver a personalized touch during guest trips, hotels are adapting new technologies to win new customers. Samsung, the industry-leading TV brand, delivers the comforts of home with the new HBU8000 series hospitality display. Featuring access to the most popular streaming services, including Netflix, in beautiful UHD quality, guests are treated to the same conveniences of their living room while traveling worldwide.



## An instantly familiar UI for faster navigation

Upon turning on their room TV, guests are treated to a recognizable UI filled with the most popular entertainment applications such as Netflix and YouTube. Guests can sign-in to dive back into the latest show they're bingeing or find new suggestions through their apps.

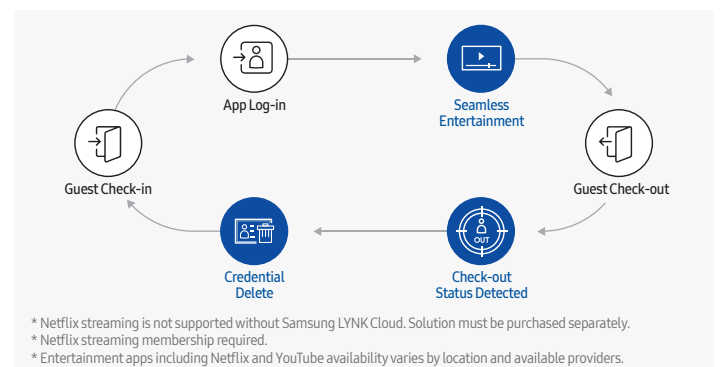

\* Netflix streaming is not supported without Samsung LYNK Cloud. Solution must be purchased separately.  
 \* Netflix streaming membership required.  
 \* Entertainment apps including Netflix and YouTube availability varies by location and available providers.

## Safe credentials management with LYNK Cloud

Guests credentials are safely saved for the duration of their trip, allowing them quick access anytime they're in their rooms. Upon checking out, credentials are wiped from the system using Samsung LYNK Cloud and the hotel's Property Management System, giving users added peace of mind.

## Key features



### Lifelike color, in its purest state with fine crystal

Elevate your hotel's entertainment experiences with Dynamic Crystal Color. With a billion shades of color, every subtlety can be seen from the comfort of the hotel room.



### Sleek and slim, more than ever

Increase flexibility with ultra-slim design, enabling hotel operators to create optimized room layouts that increase guest comfort.

## Hospitality Solution

### LYNK Cloud



### Streamlined property management

With online access that supports multiple users, Samsung LYNK Cloud is ideal for global hospitality operations with centralized management, giving users control of their hotel displays worldwide.

\* LYNK Cloud License must be purchased separately.  
\* LYNK Cloud does not support management of properties within China.

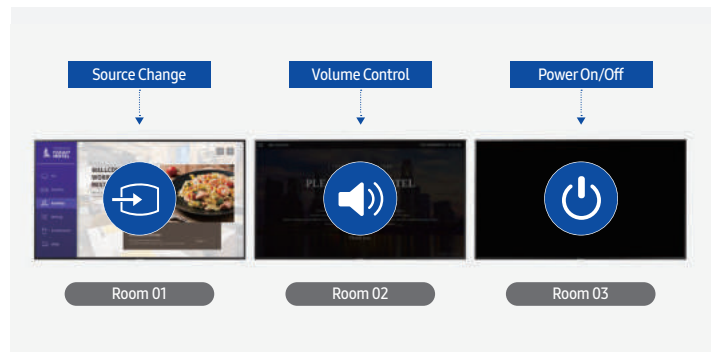

### Integrated device management

Quickly update in-room TVs from a centralized source with Samsung LYNK Cloud. Managers can modify channel maps and program guides and control basic functions, making it easier than ever to provide support and maintenance.

\* Some features may not be compatible with hotel's current platforms.

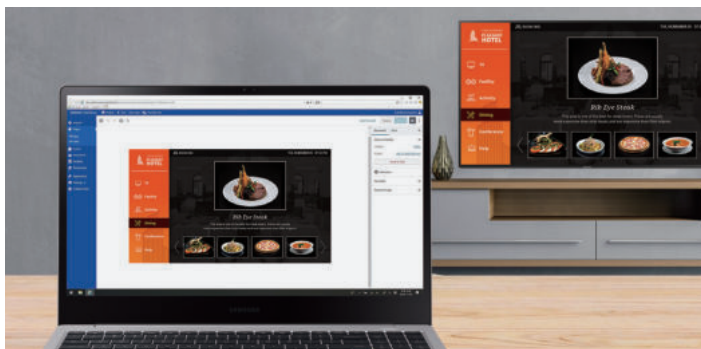

### Content creation and custom interactions

Curate your hotel's in-room experience with LYNK Cloud. Create and remotely deploy web-based content to each in-room TV for a tailored feel to your property. With interactive requests support, you can provide the easiest way for guests to make room service orders and book spa appointments.

\* Some features may not be compatible with hotel's current platforms.

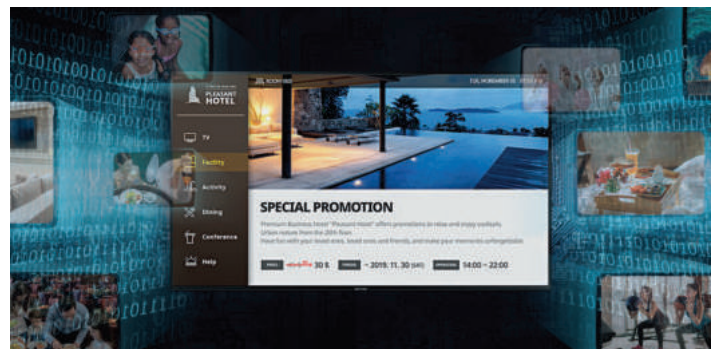

### Data-driven promotional planning

Samsung LYNK Cloud enables optimized promotional content delivery based on integrated guest data available through the hotel PMS, helping managers to uncover business insights.

# Specifications

Model		43"	50"	55"	65"	75"
		HG43BU800NFXZA	HG50BU800NFXZA	HG55BU800NFXZA	HG65BU800NFXZA	HG75BU800NFXZA
Display	Product	LED	LED	LED	LED	LED
	Resolution	3,840 x 2,160	3,840 x 2,160	3,840 x 2,160	3,840 x 2,160	3,840 x 2,160
Video	Picture Engine	Quantum Processor Lite	Quantum Processor Lite	Quantum Processor Lite	Quantum Processor Lite	Quantum Processor Lite
	PQI (Picture Quality Index)	2200	2200	2200	2200	2200
	HDR (High Dynamic Range)	HDR	HDR	HDR	HDR	HDR
	HDR10+	Support	Support	Support	Support	Support
	HLG (Hybrid Log Gamma)	Yes	Yes	Yes	Yes	Yes
	Contrast	Mega Contrast	Mega Contrast	Mega Contrast	Mega Contrast	Mega Contrast
	Color	Dynamic Crystal Color	Dynamic Crystal Color	Dynamic Crystal Color	Dynamic Crystal Color	Dynamic Crystal Color
	Micro Dimming	UHD Dimming	UHD Dimming	UHD Dimming	UHD Dimming	UHD Dimming
	Contrast Enhancer	Yes	Yes	Yes	Yes	Yes
	Auto Motion Plus	Yes	Yes	Yes	Yes	Yes
Audio	Clear Motion	LED Clear Motion	LED Clear Motion	LED Clear Motion	LED Clear Motion	LED Clear Motion
	Noise Reduction	Yes	Yes	Yes	Yes	Yes
	Film Mode	Yes	Yes	Yes	Yes	Yes
	Viewing Angle (H/V)	178/178	178/178	178/178	178/178	178/178
	Filmmaker Mode	Yes	Yes	Yes	Yes	Yes
	Dolby Decoder	MS12 2ch	MS12 2ch	MS12 2ch	MS12 2ch	MS12 2ch
	Object Tracking Sound	OTS Lite	OTS Lite	OTS Lite	OTS Lite	OTS Lite
	Q-Symphony	Yes	Yes	Yes	Yes	Yes
	Sound Output (RMS)	20W	20W	20W	20W	20W
	Speaker Type	2CH	2CH	2CH	2CH	2CH
Smart Service	Bluetooth Audio	Yes	Yes	Yes	Yes	Yes
	Dual Audio support (Bluetooth)	Yes	Yes	Yes	Yes	Yes
	Smart TV Type	Smart	Smart	Smart	Smart	Smart
	Operating System	Tizen™	Tizen™	Tizen™	Tizen™	Tizen™
	TV Plus	Yes	Yes	Yes	Yes	Yes
	Web Browser	Yes	Yes	Yes	Yes	Yes
	Screw Size	M8	M8	M8	M8	M8
	Screw depth	11-13	11-13	11-13	11-13	11-13
	VESA Spec	200 x 200	200 x 200	200 x 200	400 x 300	400 x 400
	Mobile to TV - Mirroring, DLNA	Yes	Yes	Yes	Yes	Yes
Smart Feature	Tap View	Yes	Yes	Yes	Yes	Yes
	Multi View	upto 2 videos	upto 2 videos	upto 2 videos	upto 2 videos	upto 2 videos
	Music Wall	Yes	Yes	Yes	Yes	Yes
	App Casting	Yes	Yes	Yes	Yes	Yes
	Wireless TV On - Samsung WOW	Yes	Yes	Yes	Yes	Yes
	Wired TV On - Samsung WOL	Yes	Yes	Yes	Yes	Yes
	WiFi Direct	Yes	Yes	Yes	Yes	Yes
	Sound Mirroring	Yes	Yes	Yes	Yes	Yes
	Ambient Mode	Ambient Mode	Ambient Mode	Ambient Mode	Ambient Mode	Ambient Mode
	Workspace	Advanced	Advanced	Advanced	Advanced	Advanced
Game Feature	Wireless Dex	Yes	Yes	Yes	Yes	Yes
	Web Service	Microsoft 365	Microsoft 365	Microsoft 365	Microsoft 365	Microsoft 365
	Auto Game Mode (ALLM)	Yes	Yes	Yes	Yes	Yes
	Game Motion Plus	Yes	Yes	Yes	Yes	Yes
	HGiG	Yes	Yes	Yes	Yes	Yes
	Instant On	Yes	Yes	Yes	Yes	Yes
	Voice Guide	US English, Mexico Spanish, Canada French, Finnish, German, Greek, Hungarian, Italian, Norwegian, Polish, Portugal Portuguese, Romanian, Slovak, Swedish, Czech, Danish, Dutch, Korean				
	Others	Enlarge / High Contrast / Multi-output Audio / SeeColors / Color Inversion / Grayscale / Caption Position / Sign Language Zoom / Slow Button Repeat / Separate Closed Caption / Picture Off				
	Auto Channel Search	Yes	Yes	Yes	Yes	Yes
	Caption (Subtitle)	Yes	Yes	Yes	Yes	Yes
Feature	ConnectShare™ (HDD)	Yes	Yes	Yes	Yes	Yes
	ConnectShare™ (USB 2.0)	Yes	Yes	Yes	Yes	Yes
	EPG	Yes	Yes	Yes	Yes	Yes
	IP Control	Yes	Yes	Yes	Yes	Yes
	OSD Language	English, Spanish, French				
	BT HID Support	Yes	Yes	Yes	Yes	Yes
	USB HID Support	Yes	Yes	Yes	Yes	Yes
	MBR Support	Yes	Yes	Yes	Yes	Yes
	IPv6 Support	Yes	Yes	Yes	Yes	Yes
	Digital Broadcasting	ATSC/ClearQAM	ATSC/ClearQAM	ATSC/ClearQAM	ATSC/ClearQAM	ATSC/ClearQAM
System	Analog Tuner	Yes	Yes	Yes	Yes	Yes
	Samsung LYNK Cloud	Yes	Yes	Yes	Yes	Yes
	Hospitality Home Menu	N/A	N/A	N/A	N/A	N/A
	Hospitality Home Menu 2.0	N/A	N/A	N/A	N/A	N/A
	Bluetooth Music Player (Mobile → TV)	N/A	N/A	N/A	N/A	N/A
	Hospitality Plug&Play (Easy Setup)	Yes	Yes	Yes	Yes	Yes
	Power On Mode	Yes	Yes	Yes	Yes	Yes
	Hotel Channel List	Yes	Yes	Yes	Yes	Yes
	Channel Menu Display	Yes	Yes	Yes	Yes	Yes
	Mixed Channel List (ATSC, DVB-T/T2/C/S2, Analog)	Yes	Yes	Yes	Yes	Yes
Hospitality Feature	My Channel	Yes	Yes	Yes	Yes	Yes
	Energy Saving Mode (BLU control)	Yes	Yes	Yes	Yes	Yes
	USB Cloning	Yes	Yes	Yes	Yes	Yes
	Alarm	Yes	Yes	Yes	Yes	Yes
	Samsung LYNK™ DRM RF	Yes	Yes	Yes	Yes	Yes
	Samsung LYNK™ DRM IP	Yes	Yes	Yes	Yes	Yes
	Security Mode	Yes	Yes	Yes	Yes	Yes
	Pro : Idiomi	N/A	N/A	N/A	N/A	N/A
	Pro : Idiomi SW	Yes	Yes	Yes	Yes	Yes
	WiFi	Yes (WiFi5)	Yes (WiFi5)	Yes (WiFi5)	Yes (WiFi5)	Yes (WiFi5)
Connectivity	Bluetooth	Yes (BT5.2)	Yes (BT5.2)	Yes (BT5.2)	Yes (BT5.2)	Yes (BT5.2)
	HDMI	3	3	3	3	3
	USB	2	2	2	2	2
	Ethernet (LAN)	1	1	1	1	1
	Digital Audio Out (Optical)	1	1	1	1	1
	RF In (Terrestrial / Cable input / Satellite Input)	1/1(Common Use for Terrestrial)/0	1/1(Common Use for Terrestrial)/0	1/1(Common Use for Terrestrial)/0	1/1(Common Use for Terrestrial)/0	1/1(Common Use for Terrestrial)/0
Design	Design	AirSlim	AirSlim	AirSlim	AirSlim	AirSlim
	Bezel Type	3 Bezel-less	3 Bezel-less	3 Bezel-less	3 Bezel-less	3 Bezel-less
	Slim Type	Slim look	Slim look	Slim look	Slim look	Slim look
	Front Color	BLACK	BLACK	BLACK	BLACK	BLACK
	Stand Type	FLOAT LIFT	FLOAT LIFT	FLOAT LIFT	FLOAT LIFT	FLOAT LIFT
Eco	Stand Color	BLACK	BLACK	BLACK	BLACK	BLACK
	Eco Sensor	Yes	Yes	Yes	Yes	Yes
	Auto Power Saving	Yes	Yes	Yes	Yes	Yes
Power	Auto Power Off	Yes	Yes	Yes	Yes	Yes
	Power Supply (V)	AC110-120V 50/60Hz	AC110-120V 50/60Hz	AC110-120V 50/60Hz	AC110-120V 50/60Hz	AC110-120V 50/60Hz
	Power Consumption (Max) (W)	120	150	205	260	260
	Power Consumption (Stand-by) (W)	0.5	0.5	0.5	0.5	0.5
Dimension	Power Consumption (Typical)	55	63	65	80	105
	Set Size without Stand (WxHxD)(mm)	965.5 x 559.9 x 25.7	1118.3 x 644.6 x 25.7	1232.1 x 708.8 x 25.7	1450.9 x 831.9 x 25.7	1676.7 x 960.3 x 26.6
	Set Size with Stand (WxHxD)(mm)	965.5 x 599.0 x 205.6	1118.3 x 683.6 x 228.8	1232.1 x 747.8 x 228.8	1450.9 x 869.6 x 281.8	1676.7 x 1005.5 x 340.4
	Package Size (WxHxD)(mm)	1093 x 677 x 129	1246 x 771 x 137	1399 x 846 x 148	1612 x 950 x 164	1834 x 1110 x 190
Weight	Set Weight without Stand (kg)	8.4	11.5	15.5	20.9	31.4
	Set Weight with Stand (kg)	8.7	11.8	15.8	21.3	32
	Package Weight (kg)	11.9	16	22	28.3	42.3
Accessory	Remote Controller Model	TM2280E	TM2280E	TM2280E	TM2280E	TM2280E
	Samsung Smart Control (Included)	Yes	Yes	Yes	Yes	Yes
	Slim Fit Wall-mount Support	Yes	Yes	Yes	Yes	Yes
	Optional Stand Support (Y20 Studio)	N/A	Yes	Yes	Yes	N/A
	Mini Wall Mount Support	Yes	Yes	Yes	Yes	N/A
	VESA Wall Mount Support	Yes	Yes	Yes	Yes	Yes
Power Cable	Yes	Yes	Yes	Yes	Yes	



# Technical drawings

## 43"

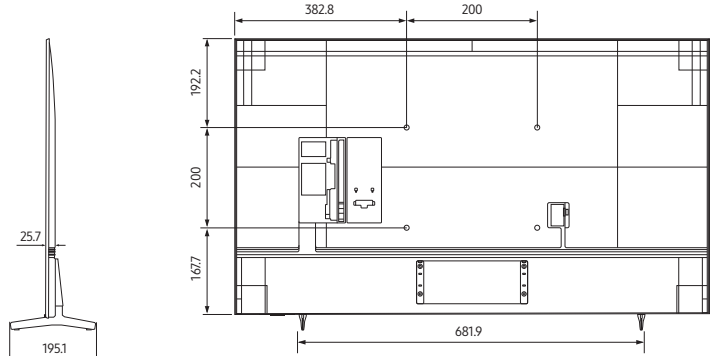
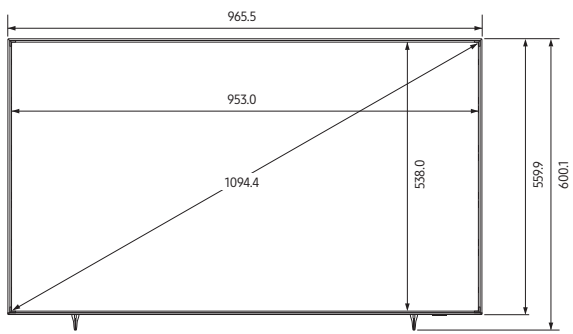

## 50"

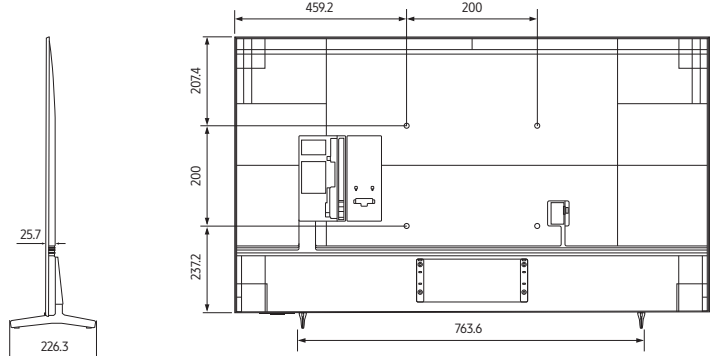
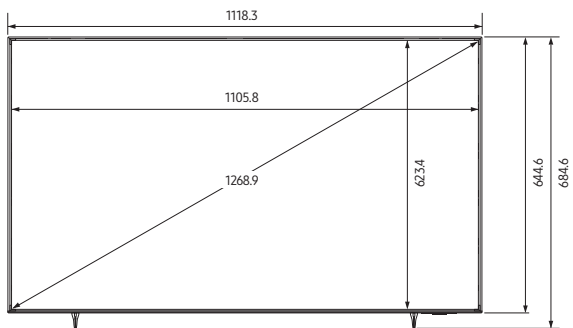

## 55"

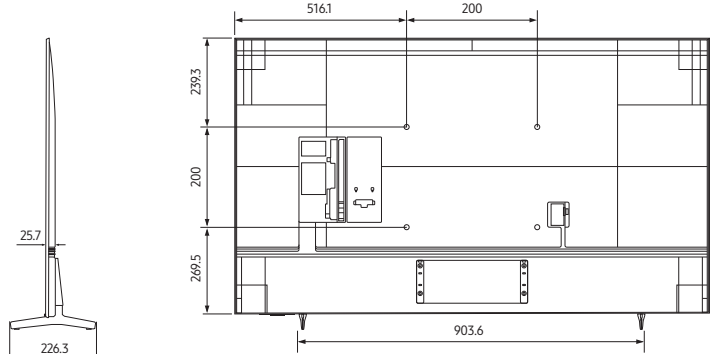
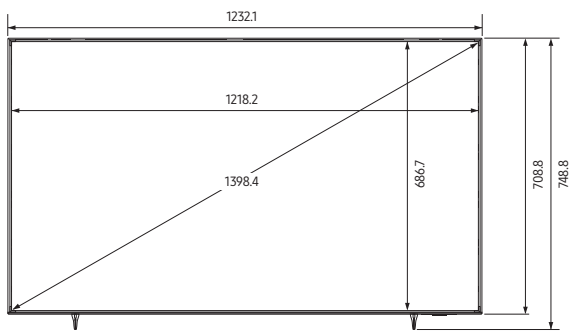

## 65"

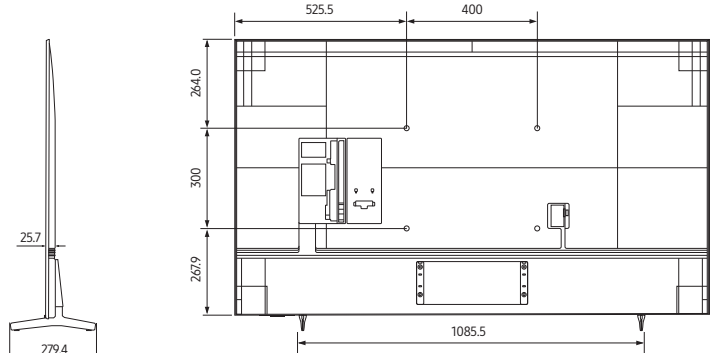
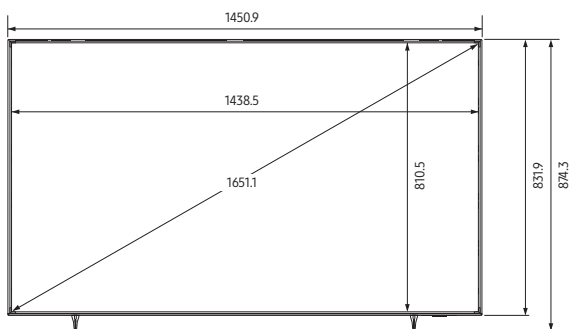

## Technical drawings

75"

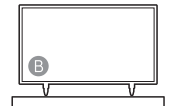
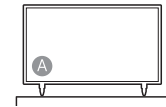
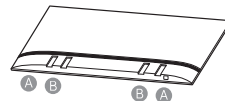
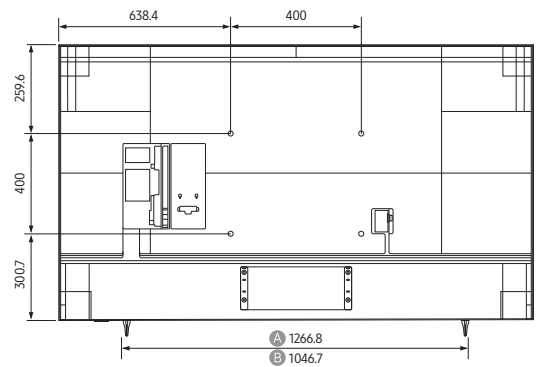
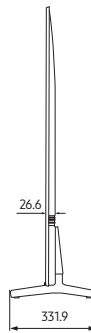
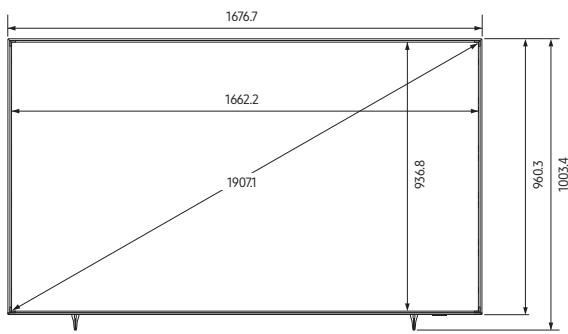

\* There are two options for the 75" stand.  
Customer can choose one of the two according to the situation.

## Connectors

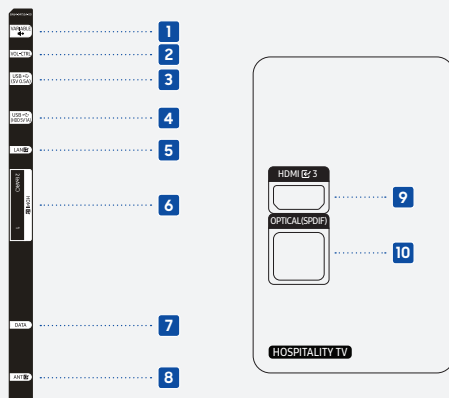

**1** VARIABLE

**2** VOL-CTRL

**3** USB (5V 0.5A)

**4** USB (HDD 5V1A)

**5** LAN IN

**6** HDMI IN 2 (eARC)  
HDMI IN 1

**7** DATA

**8** ANT IN

**9** HDMI IN 3

**10** OPTICAL (SPDIF)

## About Samsung Electronics Co., Ltd.

Samsung Electronics Co., Ltd. inspires the world and shapes the future with transformative ideas and technologies. The company is redefining the worlds of TVs, smartphones, wearable devices, tablets, digital appliances, medical equipment, network systems, and semiconductor and LED solutions. For the latest news, please visit the Samsung Newsroom at [news.samsung.com](https://news.samsung.com).

## Hospitality Display

For more information about Samsung Hospitality Displays, visit [www.samsung.com/business](https://www.samsung.com/business) or [www.samsung.com/displaysolutions](https://www.samsung.com/displaysolutions)

Copyright © 2022 Samsung Electronics Co. Ltd. All rights reserved. Samsung is a registered trademark of Samsung Electronics Co. Ltd. Specifications and designs are subject to change without notice. Non-metric weights and measurements are approximate. All data were deemed correct at time of creation. Samsung is not liable for errors or omissions. All brand, product, service names and logos are trademarks and/or registered trademarks of their respective owners and are hereby recognized and acknowledged.

Samsung Electronics Co., Ltd.  
416, Maetan 3-dong, Yeongtong-gu, Suwon-si, Gyeonggi-do 443-772, Korea